

6-M16
Stufenbohrung
Cap-Screw hole
(Detail A)

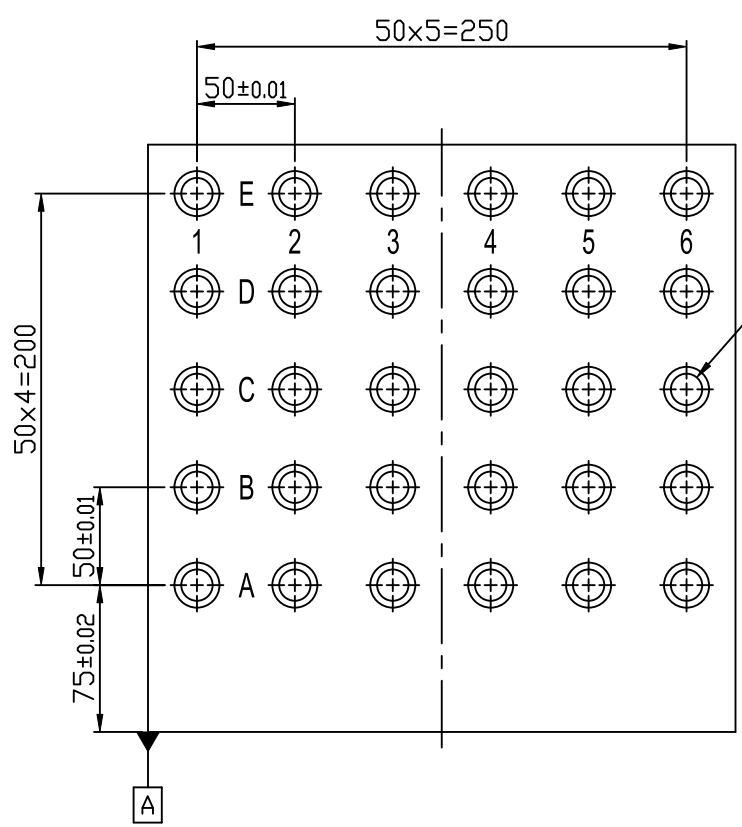

30-Ø16
Rasterbohrung
MTP hloe
(Detail B)

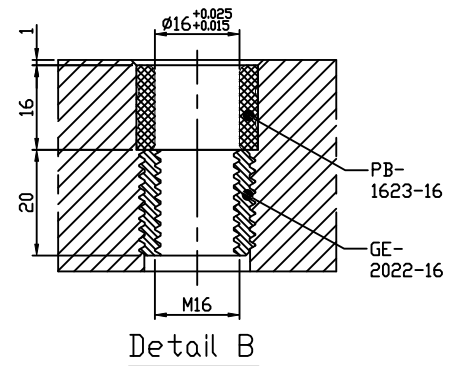
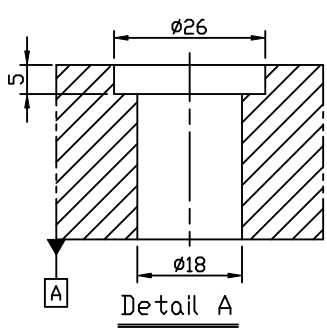
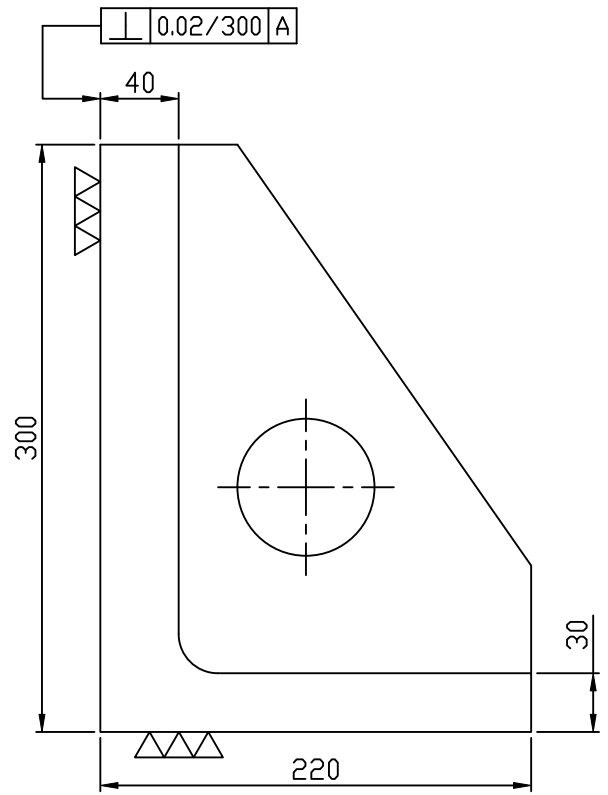

*Kanten gebrochen C2

Schutzvermerk nach DIN ISO 16016 beachten

Material EN-GJL-300 (GG 30)		Wärmebehandlung Spannungsarm geglüht			Website www.msz-tools.de		
	Maßstab	Datum 27.06.2022	Blatt 1/1	Index A	Gezeichnet von K.Merz	Kontrolliert von	Gewicht 46Kg
Bez. Aufspannwinkel mit Raster					 kompetente Spann- und Automationstechnik		
Zeichnungs Nr. RAW-220300300-02							